

FOAM CONCEPTS INC.



ARCHITECTURAL SHAPES

Since 1989, Foam Concepts, Inc., has provided the kind of dedicated service and product excellence that you would expect from the industry's leader in innovation, manufacture, design, and testing of Architectural Foam Shapes.

At Foam Concepts Inc. our foremost concern is your complete satisfaction. We have a staff of highly trained and knowledgeable salespersons, technicians, fabricators, coaters and finishers ready to help with your project from concept to completion.

We specialize in the fabrication of standard and custom Architectural Foam products. All orders are custom to your needs. We offer computer generated shapes, shutters, columns and more in either raw foam or a variety of coating options. From Base coat (plaster ready), to Smooth Coat (paint ready), to Stone Coat, to Elegant Limestone.

For commercial jobs, we offer the ICC-ES approved **STYRO-loc®** system. A unique patented system for cost effectiveness in anchoring sheet metal caps to parapet shapes. This fully tested system is only available at Foam Concepts Inc.. Log on to Stryo-loc.com for more information.

Foam Concepts Inc. also produces Veristone® coating to any of our Shapes, Columns, Balusters and more. Veristone® is a unique quarried Limestone composite with the look and feel of hand cut stone. Veristone® is available in many standard and custom colors. For more information please call one of our sales associates.

There is no job too large or small for the Foam Concepts Inc. team. We look forward to working with you on your next project.

Foam Concepts Inc. 4729 E. Wesley Dr. • Anaheim, CA 92807
(714) 693-1037 • (888) 693-1037 • Fax: (714) 693-3029





SHAPES

FC-48

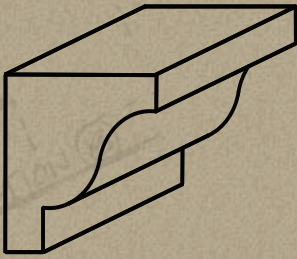

FC-51

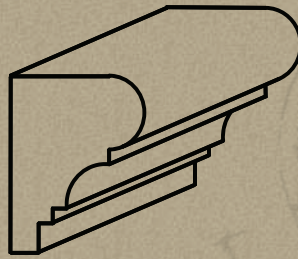

FC-52

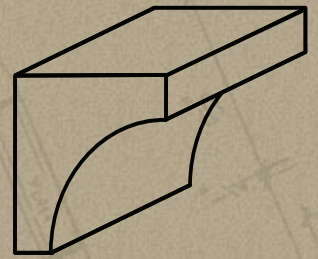

FC-53



FC-55

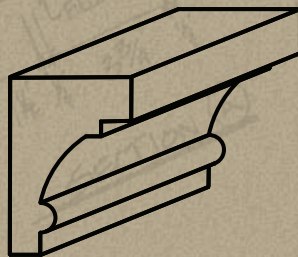

FC-56

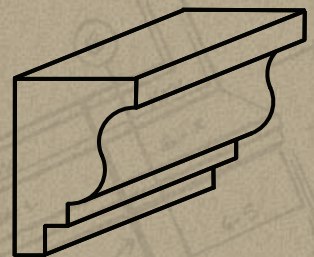

FC-57

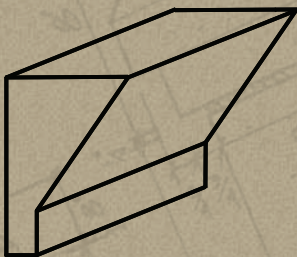

FC-58



FC-59

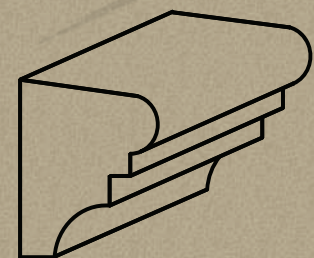

FC-60

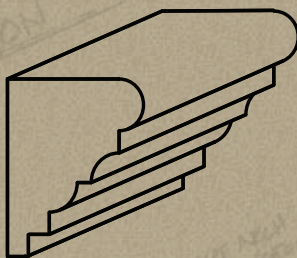

FC-61



FC-62



FC-65

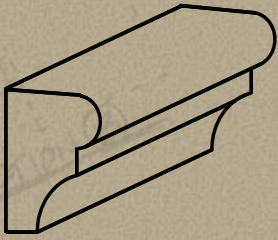

FC-67

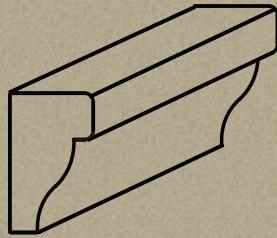

FC-70



FC-72



FC-73

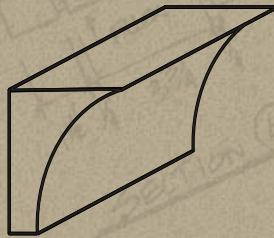

FC-74

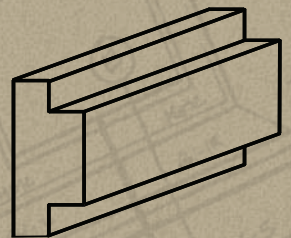

FC-75

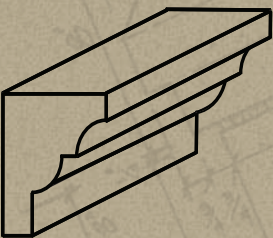

FC-76

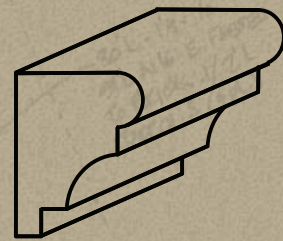

FC-78

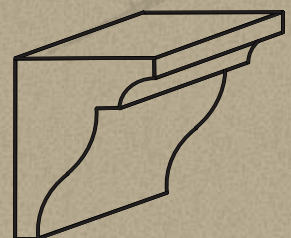

FC-79

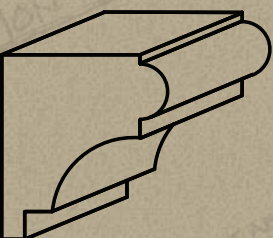

FC-80



FC-81

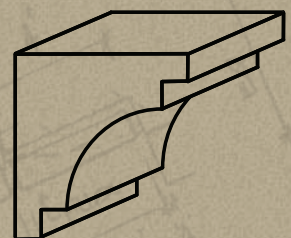



11324

FC-83

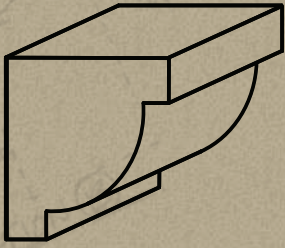

FC-84

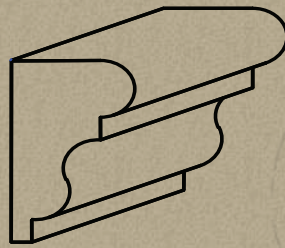

FC-86



FC-87



FC-88



FC-89



FC-94

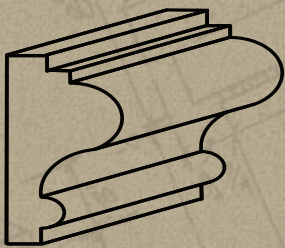

FC-100

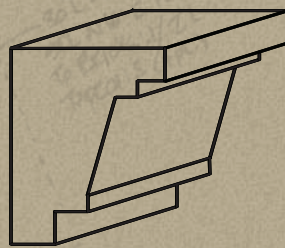

FC-101

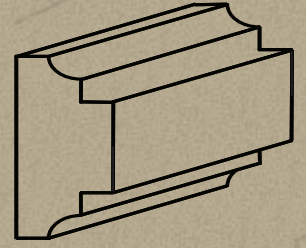

FC-102

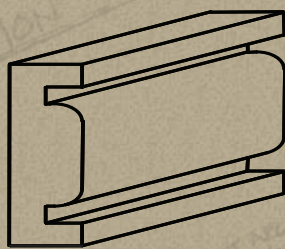

FC-104

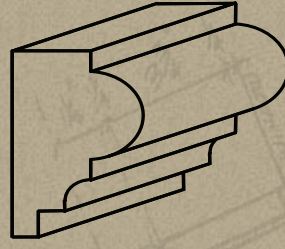

FC-107

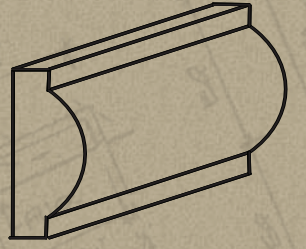



COLUMNS

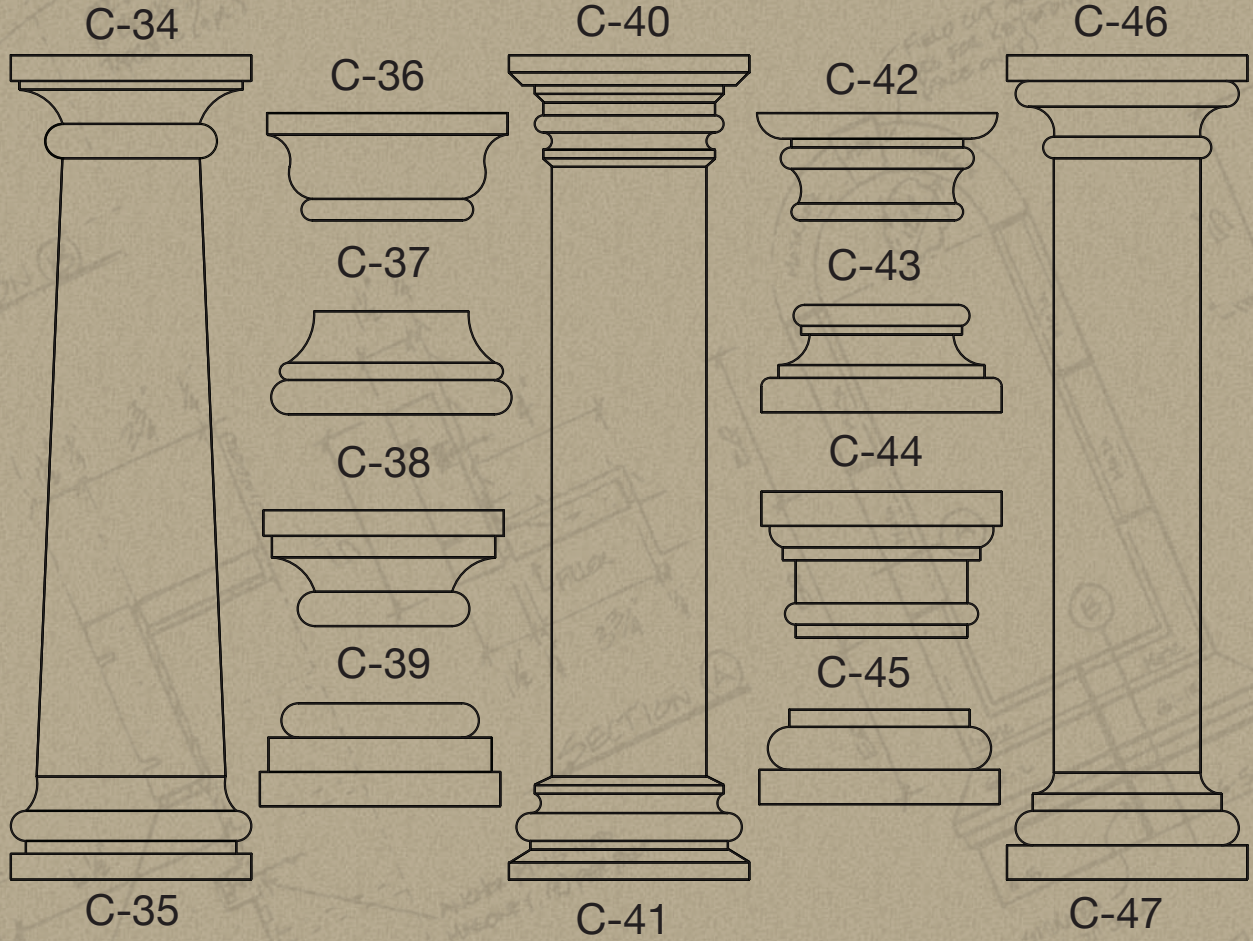

ROUND



SQUARE

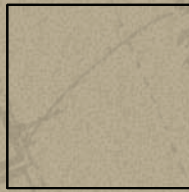

FLUTED

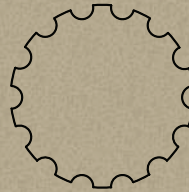

HALF

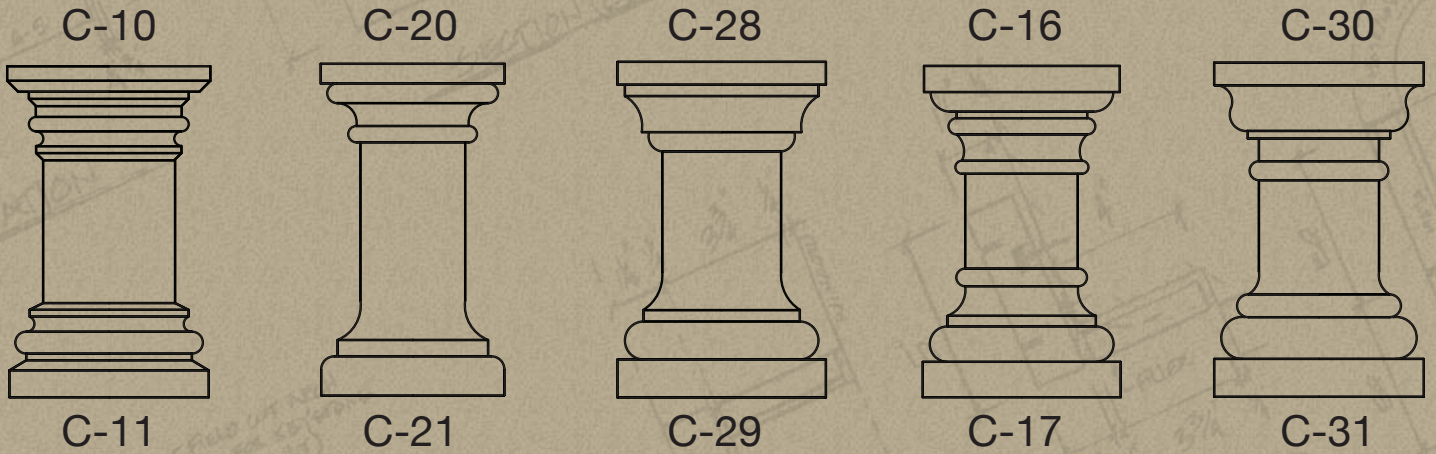



SHUTTERS

TYPE A

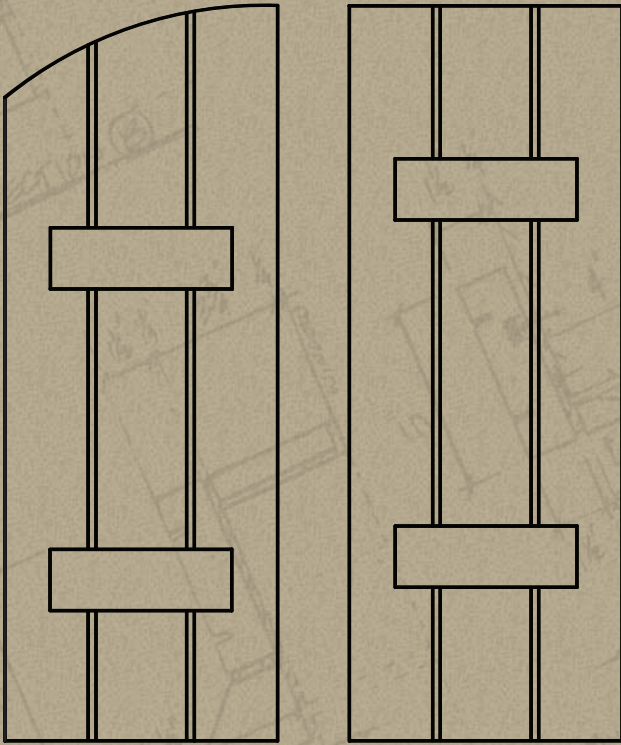

TYPE B

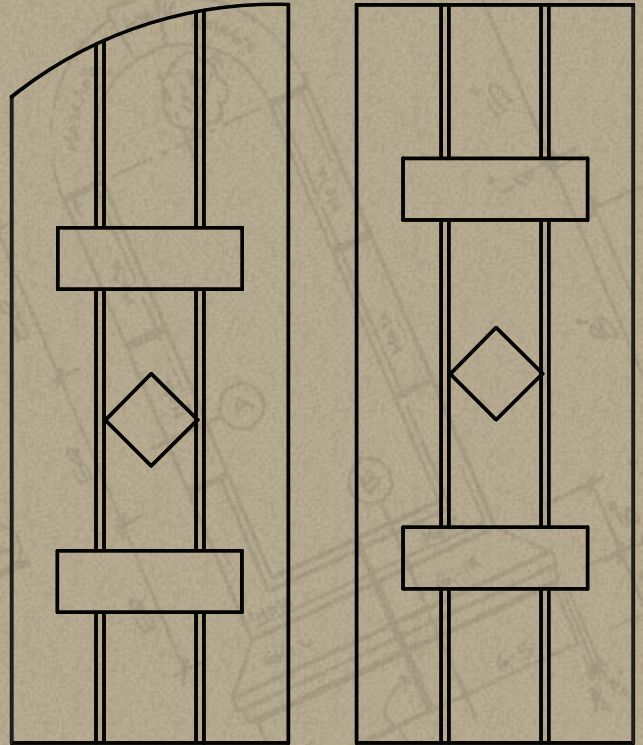

TYPE C

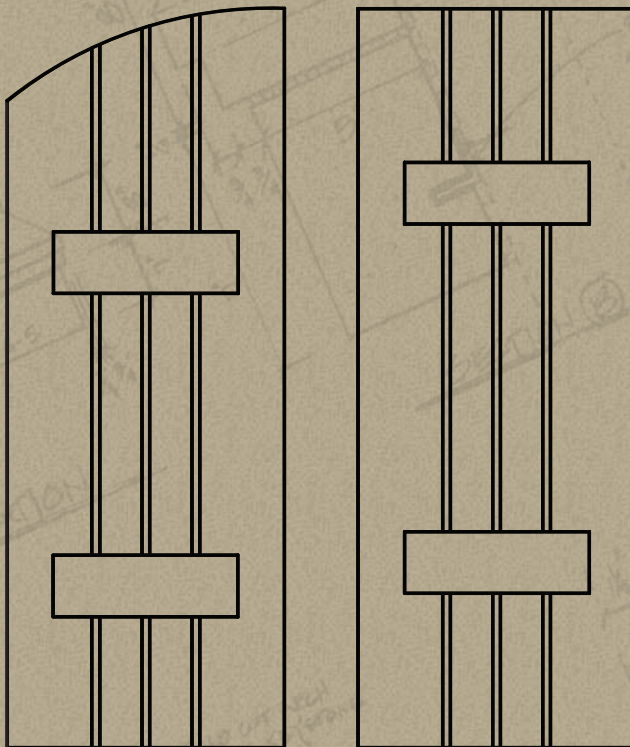

TYPE E

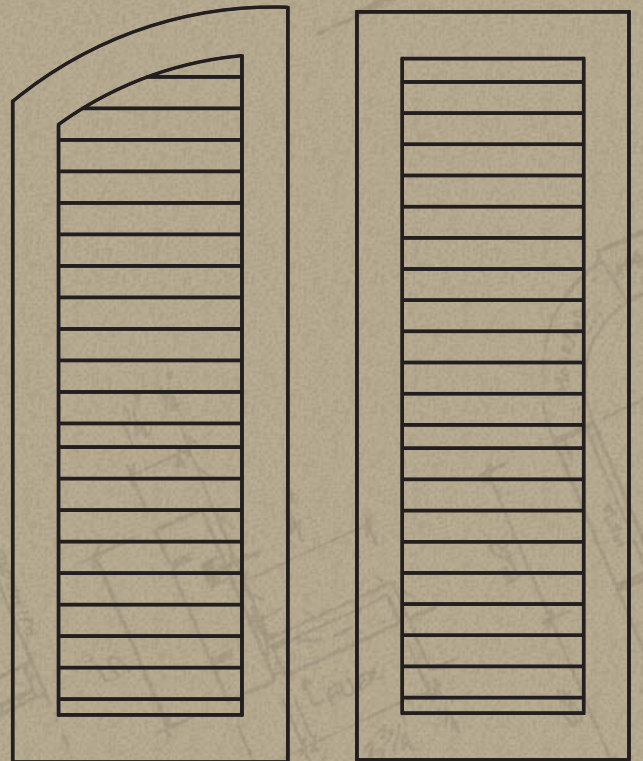

WALL CAPS

WC-1

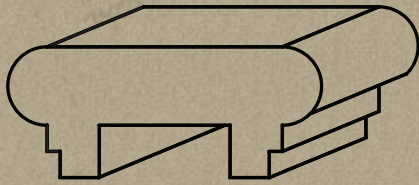

WC-2

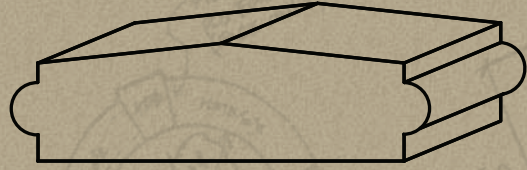

WC-4

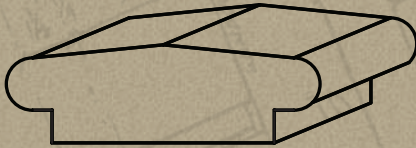

WC-5



PILASTER CAPS

PC-10

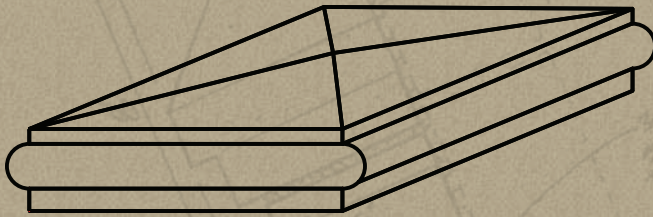

PC-11

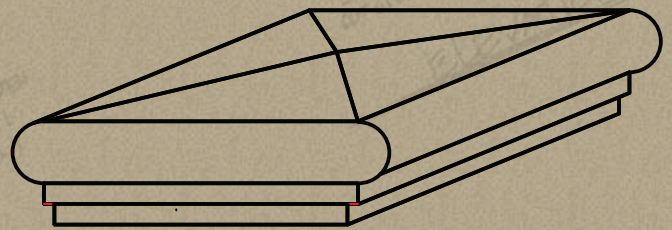

FORM LINERS

FL-10

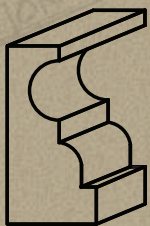

FL-11

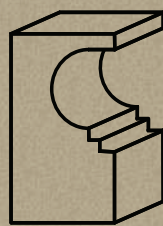

FL-24



FL-30

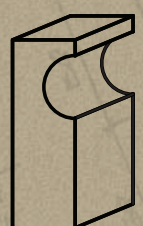



ACCESSORIES

ROSSETTES

Q-2

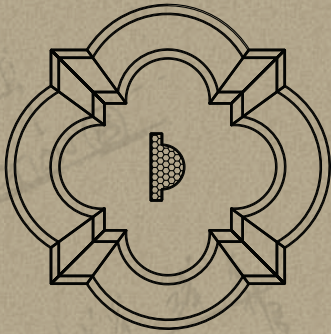

Q-3

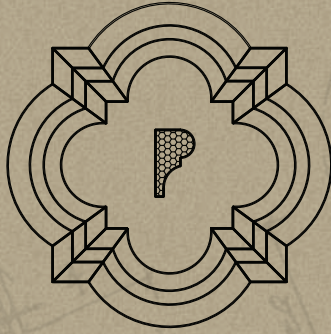

Q-4

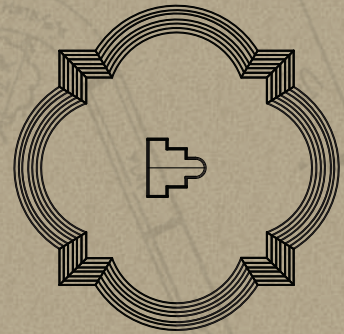

Q-5

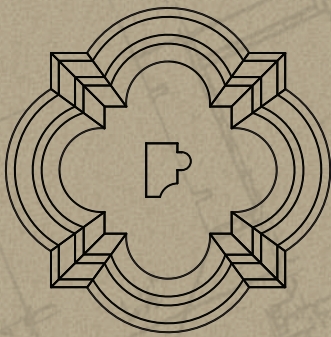

Q-6



Q-7

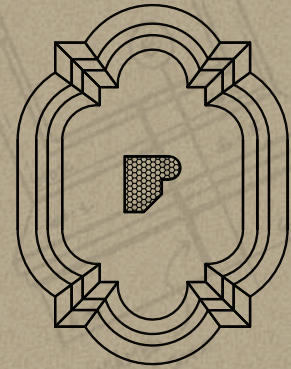

QUOINS

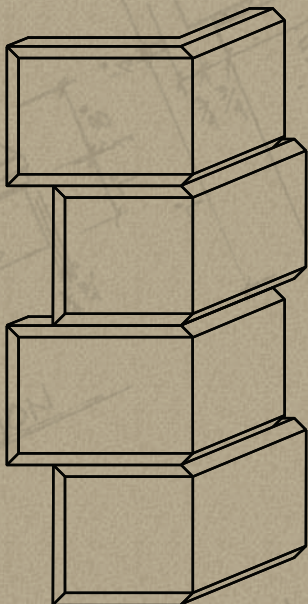

KEYSTONES

K-1

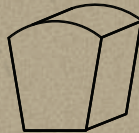

K-2



K-3

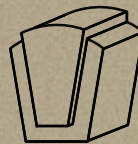

K-4

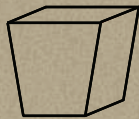

PIPES

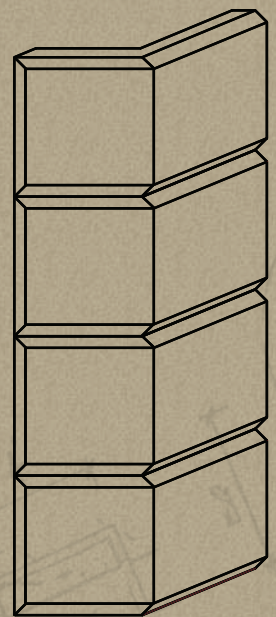

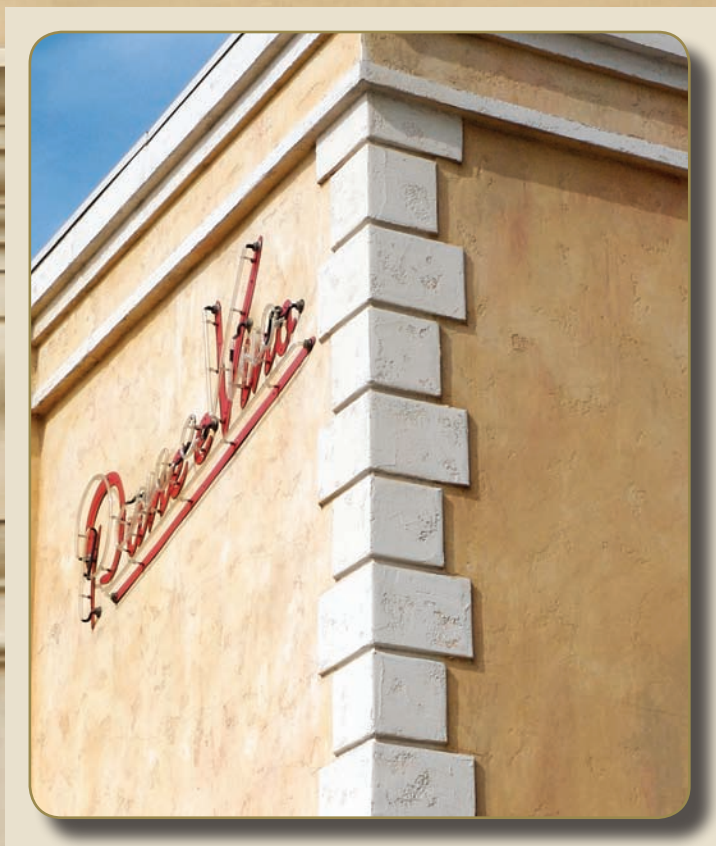

STYRO-loc®

THE ONLY ICC APPROVED PATENTED SYSTEM
GUIDELINES BASED ON TESTED SAMPLES

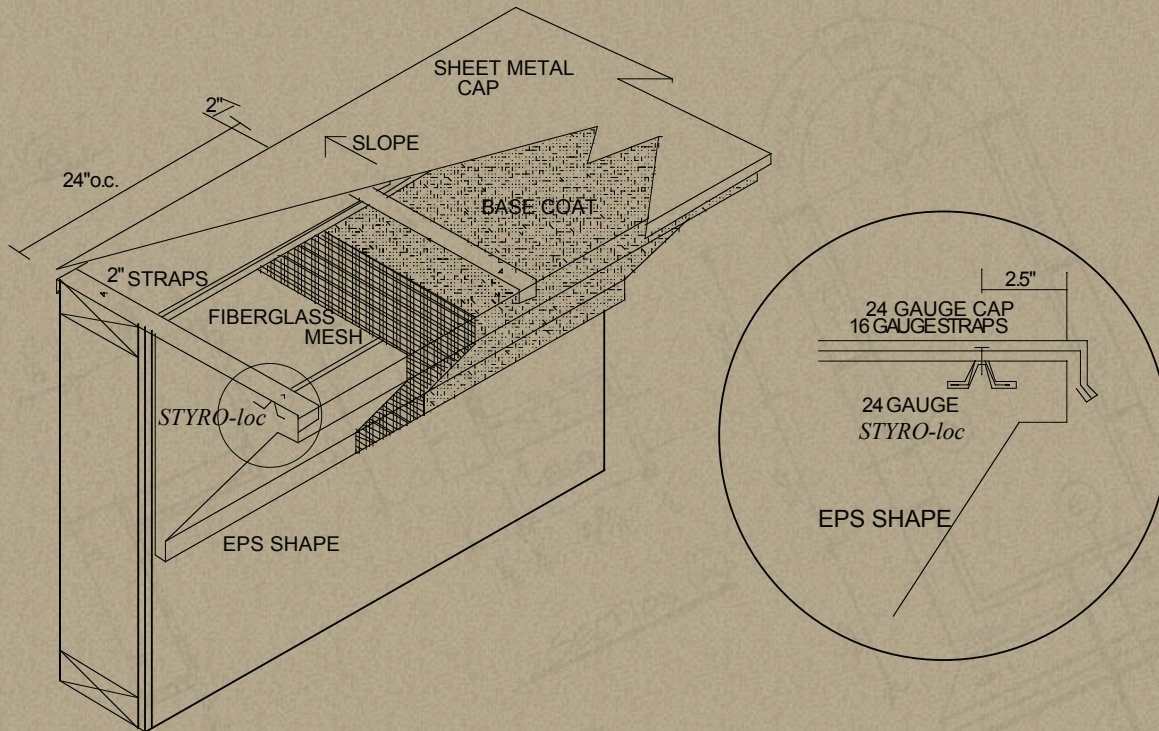

An innovation in anchoring that's so revolutionary that it has been awarded a United States patent.

STYRO-loc®... Secures parapet cap flashing ... Eliminates parapet plywood. Allows anchoring of flashing straps into integrated components... Increases structural integrity of foam... load values tested to 6,330 pounds per square foot.

If simplicity is standard, than **STYRO-loc®** is simply standard to the industry. Channels enfold the galvanized anchor bars, simplifying alignment and giving the fitted look of sculpted parapets. Coupled with appropriate adhesives, **STYRO-loc®** increases the integrity of your parapet, and virtually eliminates warped cap flashing.

The patented **STYRO-loc®** system is available only from Foam Concepts Inc. and is supplied in 24 – gauge galvanized metal.

For additional information visit www.STYRO-loc.com or call a Foam Concepts Inc. representative.

Patent Number 5,661,929

Foam Concepts Inc. 4729 E. Wesley Dr. • Anaheim, CA 92807
(714) 693-1037 • (888) 693-1037 • Fax: (714) 693-3029

